

Article number: 604145064055

Description: Timing belt pulley with hub
HTD 64 14M 55

Measures

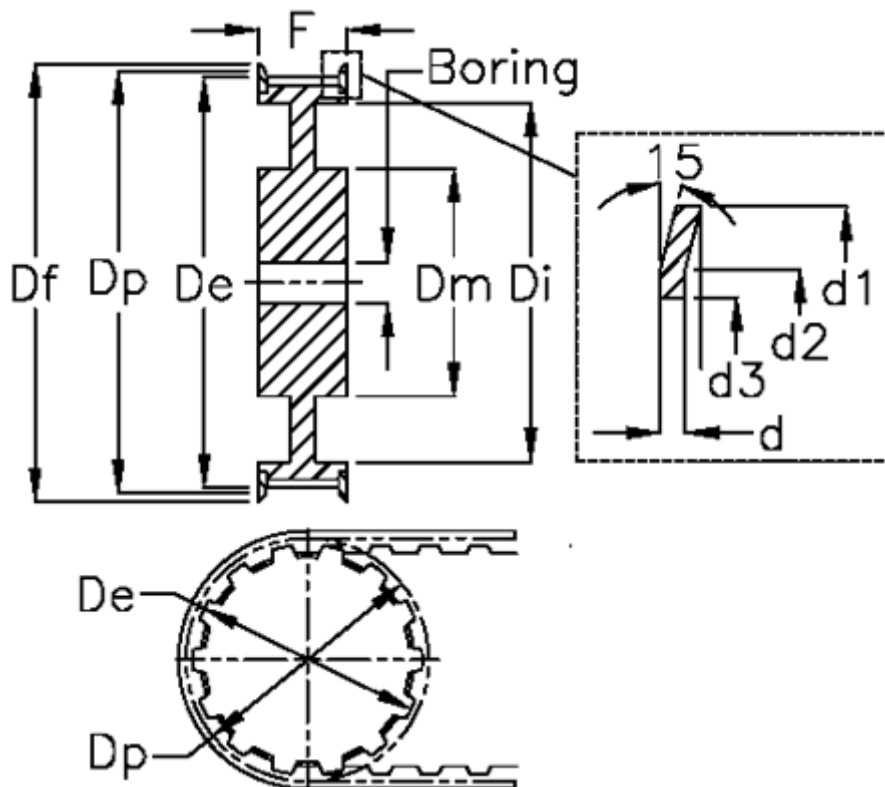

Bore = 28	Dm = 135	Width = 55
d = 2.5	Dp = 285.21	
d1 = 296	F = 240	
d2 = 287	Flange type = F70	
d3 = 260	L = 70	
De = 282.41	Tooth number = 64	
Df = 296	Type = 14M	
Di = 70	Weight = 15.6	